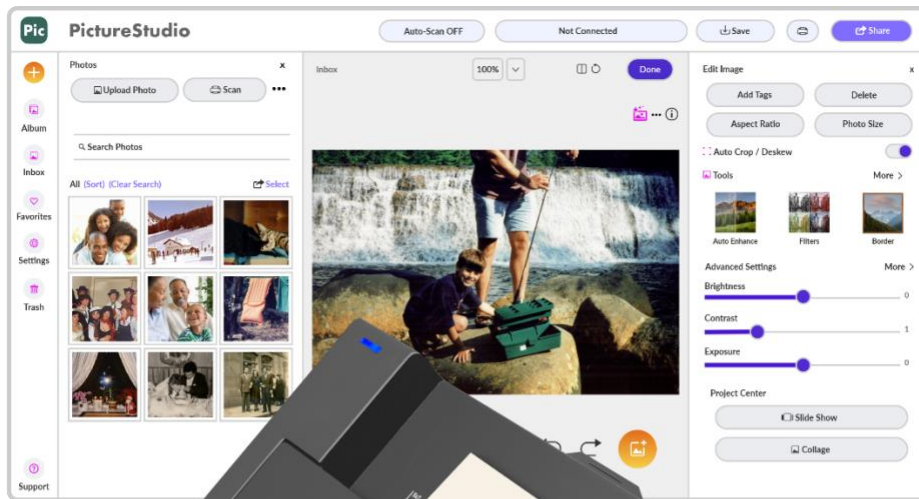

Photo Scanner

with **PictureStudio** by **AMBIR™**

Model PS400



Contents

- Safety Precautions 3
- Downloading and Installing PictureStudio Software 4
- Connecting your Photo Scanner 6
- Navigating the PictureStudio App..... 8
- Uploading photos from your computer 11
- Scanning photos..... 9
- Scanning Your First Photo 9
- Image Editing 12
- Advance Settings..... 22
- Project Center 24
- Slide Shows 24
- Collages 27
- Settings..... 28
- Trash..... 30

This product is designed to help you easily scan photos and convert them into digital images that can be shared, stored, and preserved. You can effortlessly transfer digital images to your computer. Additionally, the Scanner comes with the feature-rich PictureStudio Software, which provides a full range of photo editing capabilities.

This user manual is intended to provide you with guidance on how to operate this product. Any use outside of the instructions contained in this guide may void the warranty. This product is covered by a limited one-year warranty, which is subject to certain limits and exclusions.

Safety Precautions

Warning: This product contains small parts and is not suitable for children under three years old.

Warning: Do not attempt to disassemble or alter this product. This device contains no user-serviceable parts.

Important: Do not expose this product to liquids or high humidity. Do not handle this product with wet hands to avoid the risk of electric shock.

Do not move or disconnect the device from the computer while the device is reading or writing data. This may cause damage to the device and or the data.

<https://picturestudio.com/>

Photo Scanner Model PS400

Downloading and Installing PictureStudio Software

1. Connect the USB cable that came with your Scanner to the port on the underside of the scanner and your computer's USB port. Please use the included adapter if your computer only has USB-A ports.

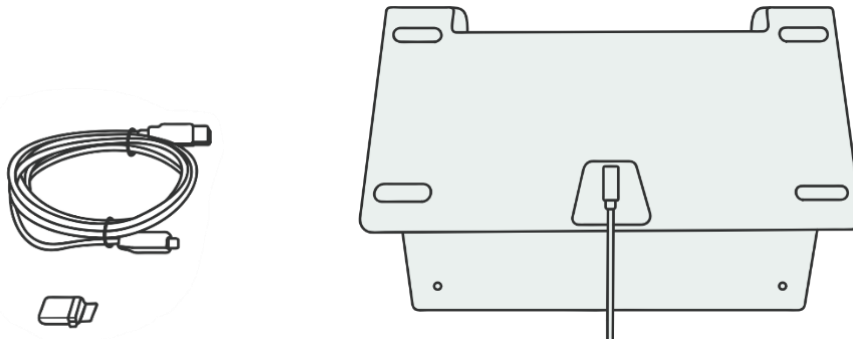

The green power light at the top of the Photo Scanner will illuminate indicating the scanner is connected.

2. Download the software here <https://picturestudio.com/setup/>
3. Once the file is downloaded from the website, open it to start the installation process. A popup will appear, asking permission to run the PictureStudio file on your device. Click “Yes” to proceed.
4. During the installation process, you will be prompted to connect your scanner. Please use the provided USB cable to connect the scanner to your device. Once connected, press “OK” to continue.

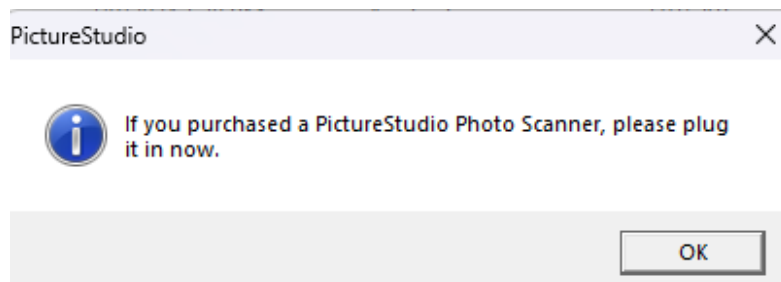

5. After clicking “OK”, the PictureStudio will now begin to installation process.

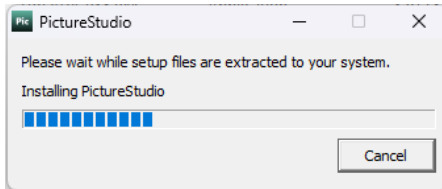

6. Follow the next steps to properly set up PictureStudio on your device. Once complete, click “Next” to start the Setup.

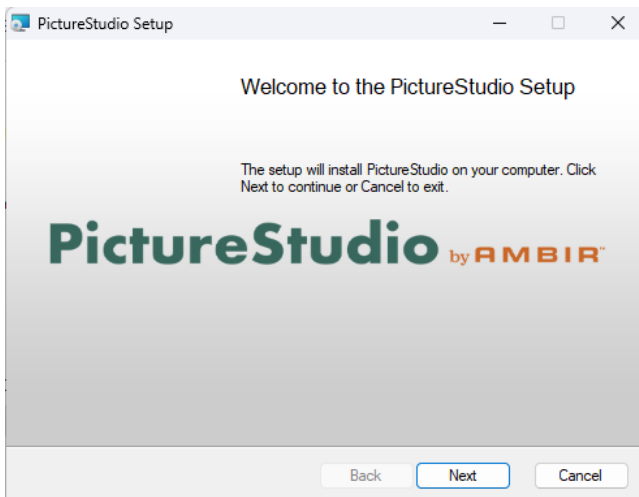

When the installation is complete, the PictureStudio App will open.

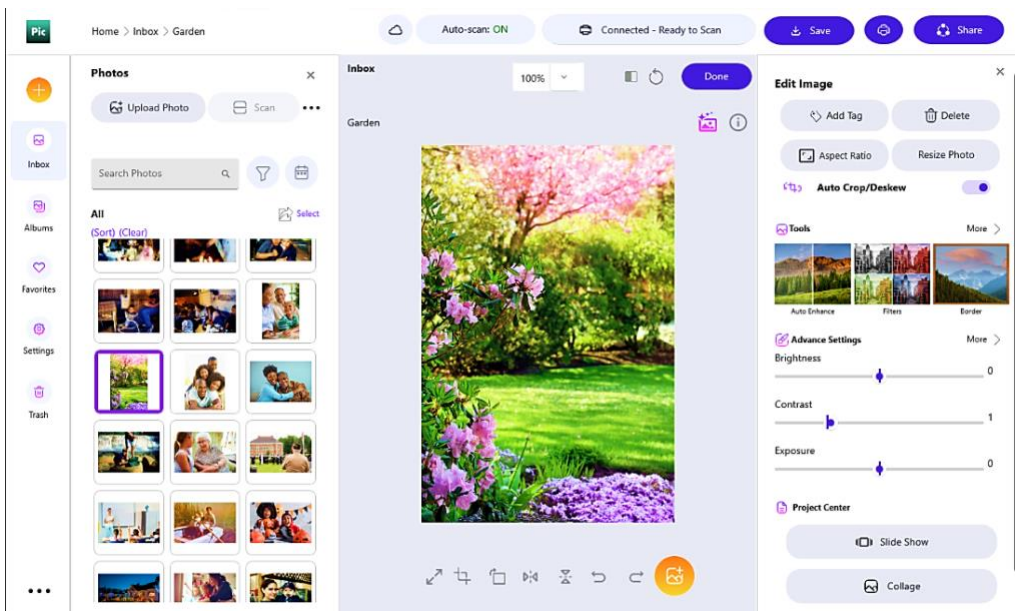

When the application is launched, the PictureStudio Registration window will appear. Take this opportunity to register your product for warranty coverage and receive updates and feature enhancements notifications. After completing the requested information, click “**Submit**”.

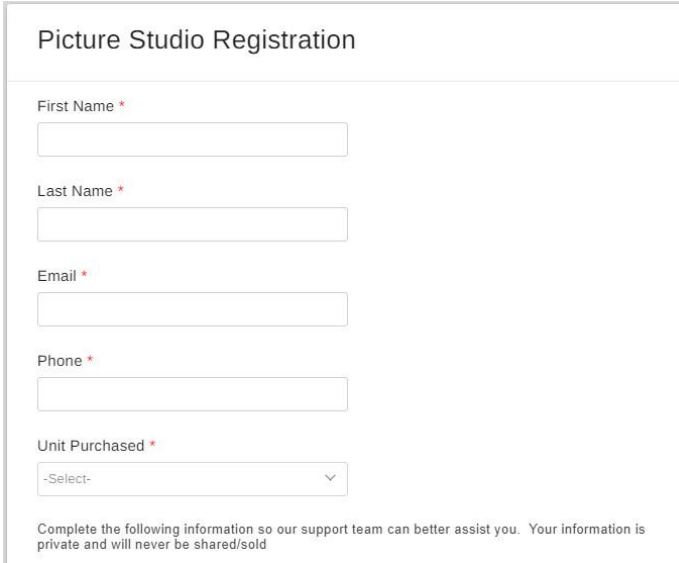

The screenshot shows a registration form titled "Picture Studio Registration". It contains five input fields: "First Name *", "Last Name *", "Email *", "Phone *", and "Unit Purchased *". The "Unit Purchased" field is a dropdown menu with "-Select-" and a downward arrow. Below the form, there is a small disclaimer: "Complete the following information so our support team can better assist you. Your information is private and will never be shared/sold".

Initial Scanner Setup and Calibrating

1. Connect Scanner to New Device: When first connecting your scanner to a new device, the “Calibrate Scanner” window will open.
2. When prompted, place the provided calibration sheet in the scanner with the arrows pointing down toward the front of the Scanner.
3. Calibrate Scanner: After inserting the calibration sheet, click “**Calibrate**”. During calibration, the power light on the scanner will turn blue. The scanner will automatically move the calibration sheet up and down, determining the correct reference settings.

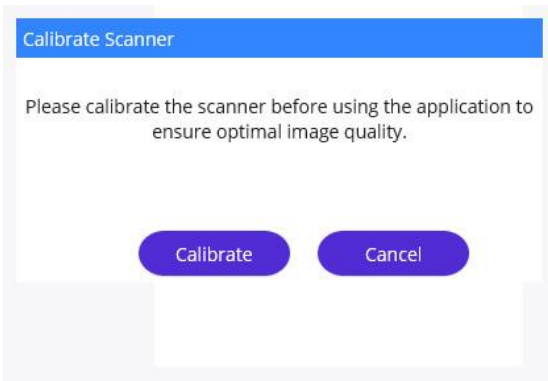

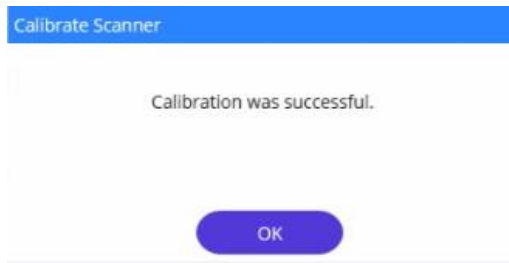

4. Complete Calibration: Once the calibration has been successfully completed, click “OK”

Post-Calibration and Settings Adjustment

Regular Calibration: After the initial setup, calibration may be required from time to time to ensure the highest performance and image quality. To calibrate, select “Calibration” from the Settings menu and follow the instructions.

After the initial calibration, the **Scanner Settings** page will open showing the current default settings. From the Settings page, you will have the ability to adjust settings, configure functionality, and integrate with other applications. (See Settings starting on Page for additional details.)

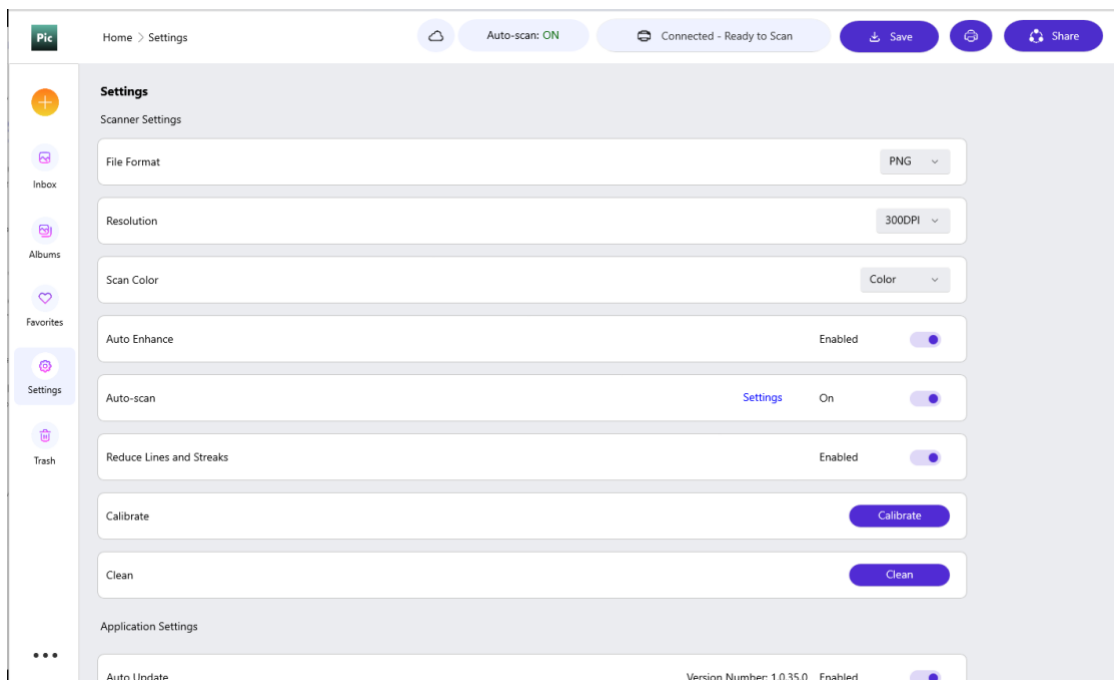

Navigating the PictureStudio App

The first time the App opens, click **“Inbox”**. PictureStudio is now ready to use.

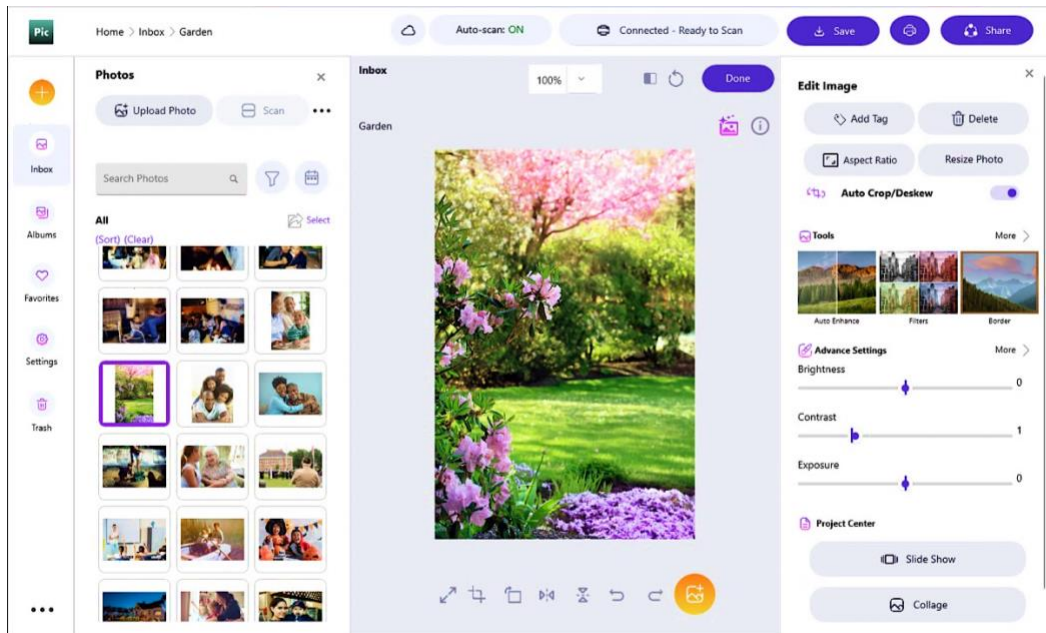

PictureStudio offers a wide range of capabilities and features. Let’s take a closer look at them.

The left navigation column shows you various options for organizing your photos and accessing additional information.

Inbox Folder: The top icon is the inbox folder, which opens by default when the app launches. This is the default location for all scans and imports. You can create or select other destinations from by clicking the three dots next to the Scan button or selecting a default location in Settings.

Albums: Create custom albums to organize your photos by events, themes, or any criteria you choose.

Favorites: Highlight your most cherished photos by simply clicking the “heart icon” in the lower corner of each photo. Your favorites are now instantly accessible.

Scanning photos

1. To scan a photo, please a photo in the feed tray, then select "Scan". The photo in the paper tray will be feeding into the scanner. Newly scanned photos will appear in the viewer to the left of the canvas.

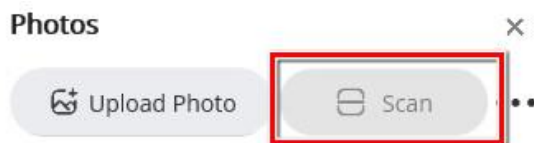

2. The three dots next to the Scan button, provide quick access to a range of scanning options, To access the menu of options, simply click the dots.

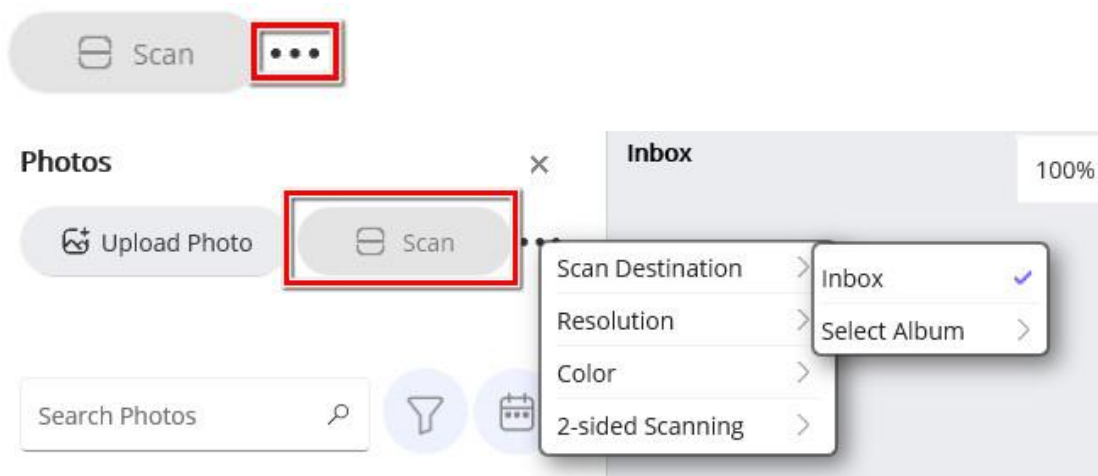

From this menu, you can select or create a destination Folder, adjust scan resolution (300DPI or 600DPI), select color (Color or Grayscale), and enable or disable 2-sided scanning.

Scanning Your First Photo

Let's start by scanning one of your favorite photos.

1. Scanning can be done in 2 ways, **Auto scan (default)** or **Manual scan**.
2. **Auto Scan enables you to scan photos without having to click buttons in the app. You simply place the photo** upside down and with the top of the photo pointed towards the front and bottom of the scanner **into the feed tray. One the photo is detected; the scanner will automatically begin to scan.** After a few seconds you will see the photo

image appear as a thumbnail image in the **Photos Viewer**, left of the canvas. **You can** enable or disable, and adjust settings for Auto-scan from the Settings menu.

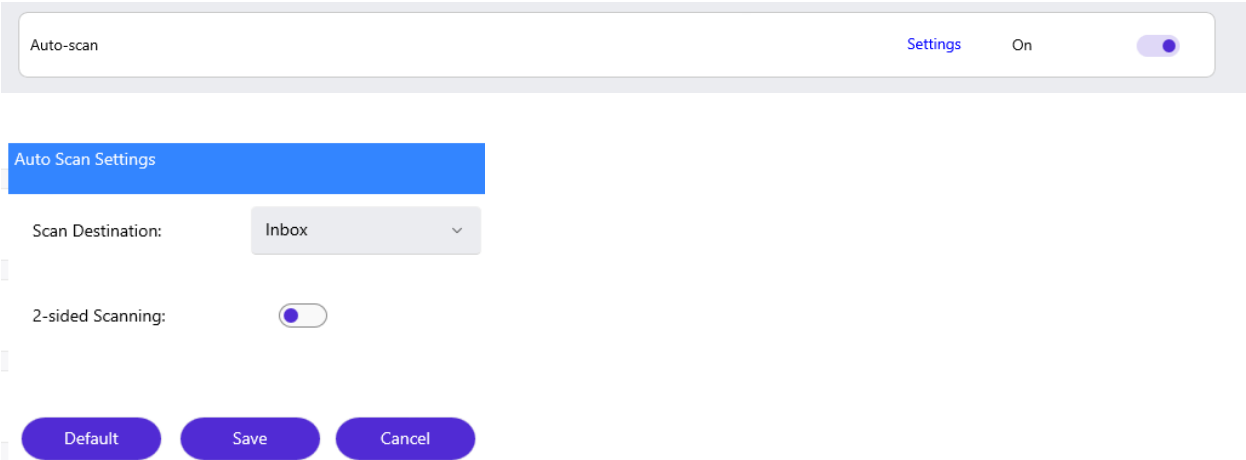

3. **Manual scanning.** Place a photo into the feed tray (face down, with the top of the photo pointed towards the bottom of the scanner). Once set, select the “Scan” button location in the top left menu of the app. The scanner will feed the photo through automatically and will exit out the bottom. The photo will appear as a thumbnail image in the **Photos Viewer**, left of the canvas.
4. To view or edit an image on the canvas, click the thumbnail and it will appear on the canvas.
5. The row of editing tools that appear under the selected image in the canvas, enables you to expand the canvas by collapsing the side menus, crop, rotate, invert, and undo/redo steps during the editing process.

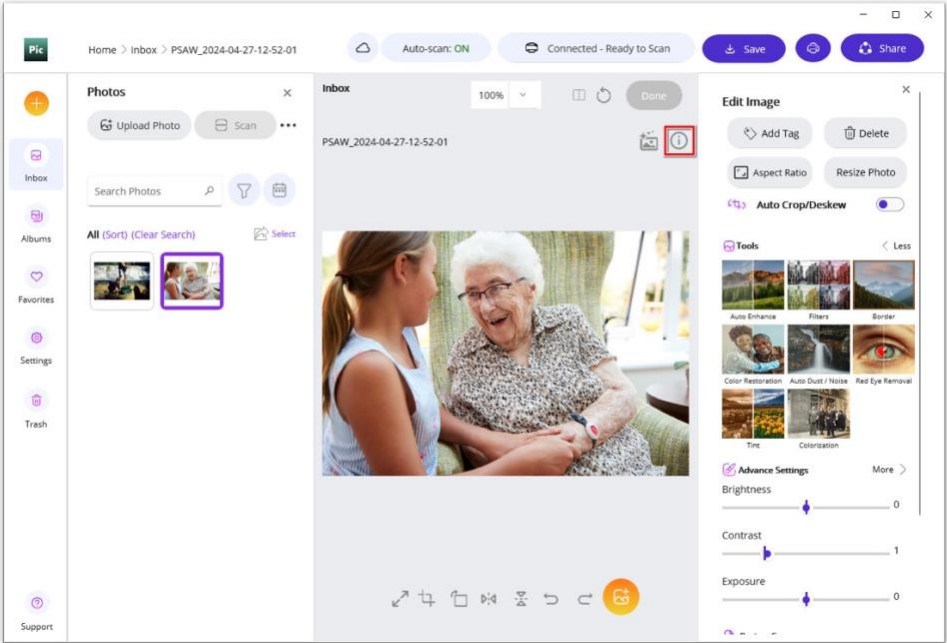

- To add information about the scanned image, click the .



Name
PSAW_2024-04-27-12-52-01

Date
04/27/2024

Location

Notes

Tags

From the information box, you can change the name, location, and date of the photo. These notes and tags will help you easily find saved photos when using the search function. (see Add Tag Section for additional detail.)

Uploading photos from your computer

- To upload a photo from your local drive, select **“Upload Photo”**.

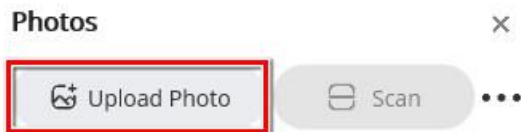

- Locate the folder and select the photos you wish to import.
- After selecting the photos you want to import, click **“Open”**.

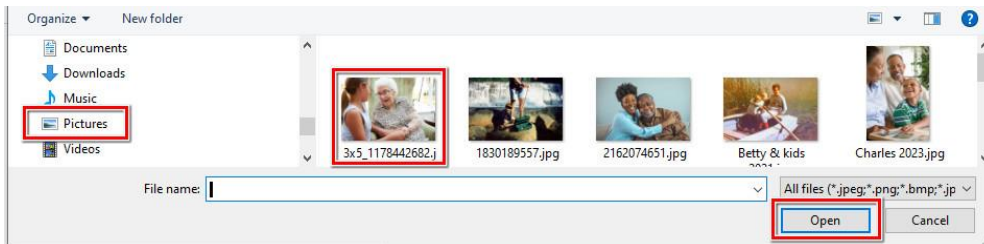

4. After the selected photos are imported, a popup window will appear confirming that the import was successful.

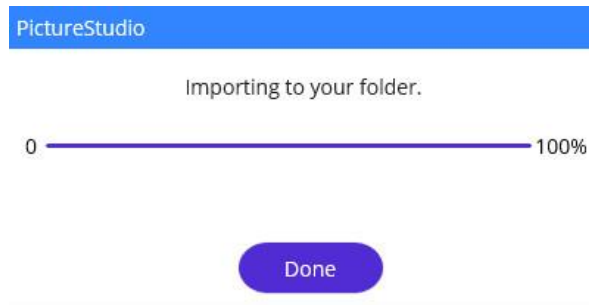

5. After the import process is complete, click “**Done**”. The photos can be found in your inbox or selected album.

Image Editing

The **Edit Image** panel on the right of the app includes several options for manipulating your photos. You can enhance it, crop it, resize it, and perform many other edits!

Let’s explain one feature at a time.

After modifying a photo image, you may see this warning.

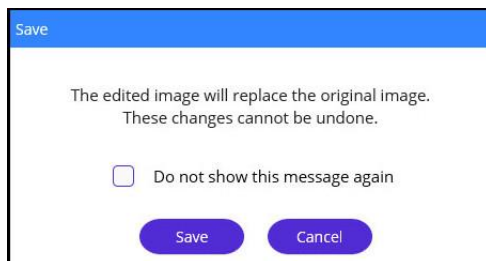

Be sure if you want to keep your changes. You can always restore your edited photos by selecting the “restore icon” at the top of the canvas. Alternatively, you have the option of duplicating the image before editing by selecting the thumbnail, right-clicking over the selected image, and selecting “Duplicate” from the menu. A replica of the selected image will be saved in the same folder.

At the top of the panel you’ll see this:

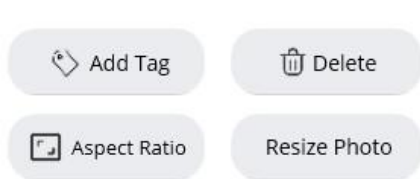

Add Tag

1. Have your photo selected on the canvas if you wish to add a tag. Click on the “Add tag button” on the right of the canvas. Once clicked it will have a blue outline to indicate you are now in Tagging mode.

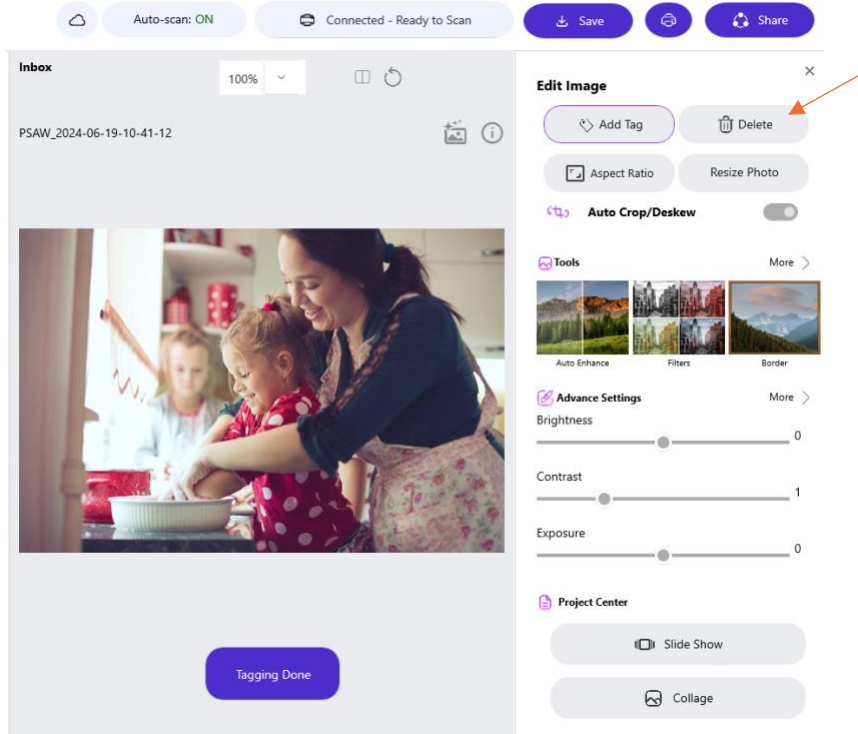

2. Click on any person or area on the photo and a tagging box will appear to enter a tag name. Click enter to save the tag.

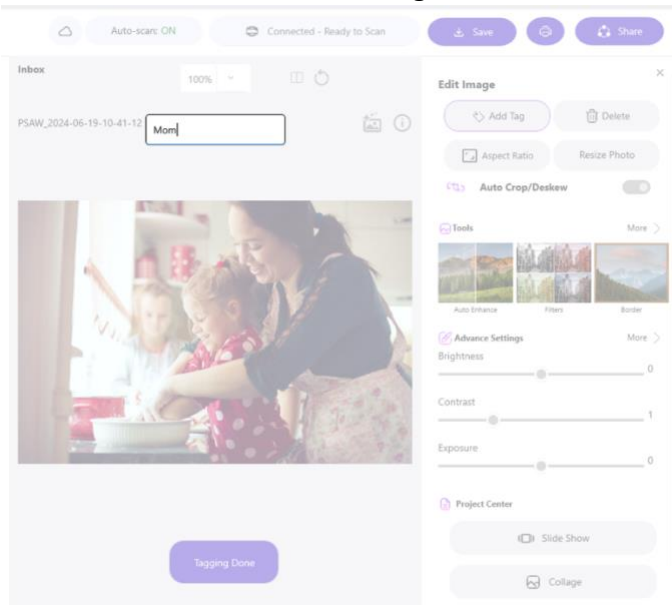

Tags will appear in the area you clicked within the photo.

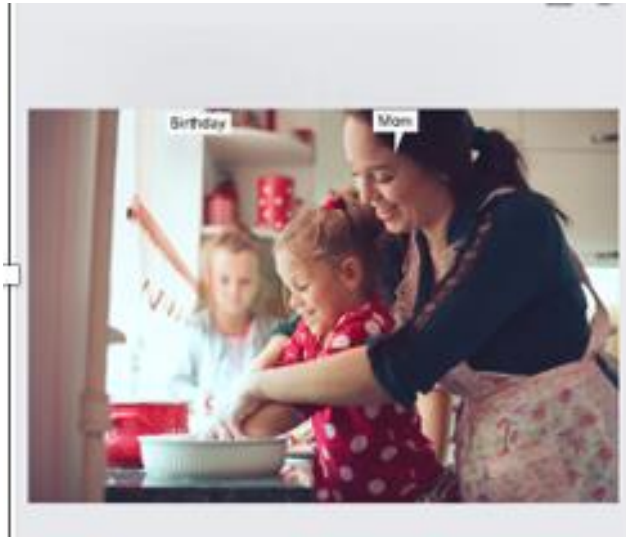

3. When you have finished tagging your photo, click the **“Tagging Done”** button below the image, then **“Done”** at the top of the canvas to save all tags and edits.
4. Your photo has been tagged. To see the tags, navigate to the information icon that appears just above the image on the canvas. These tags are now searchable and can be used to quickly find saved photos.

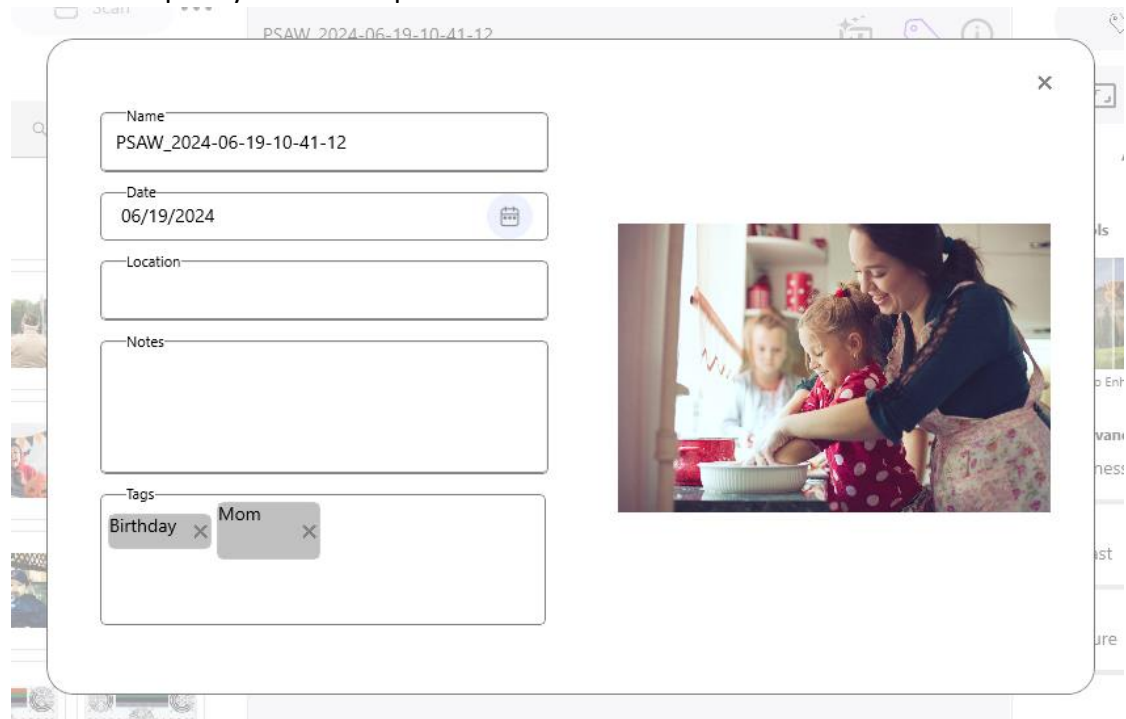

Deleting from Viewer

After clicking a photo in the **Inbox**, **Albums**, or **Favorites** folder, you can remove it from the folder by clicking **Delete**.

Aspect Ratio

1. Clicking **Aspect Ratio** opens a panel of choices.
2. For our example, select **3:2**.

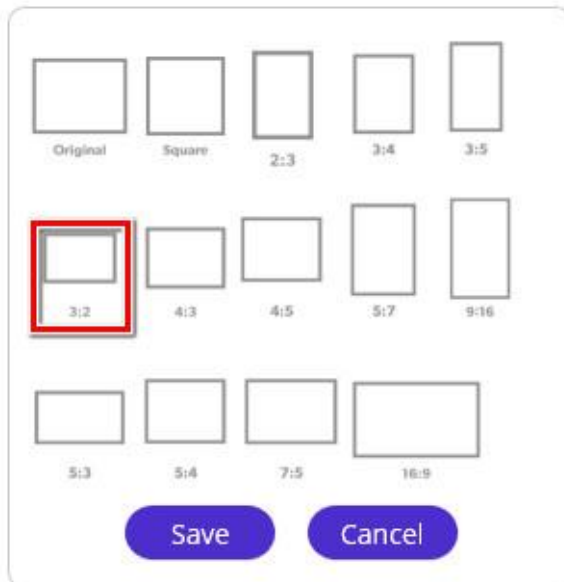

A frame appears around the photo.



If you want to change the field of view, you can do that by manually dragging the *sides* of the square. The selected aspect ratio will be maintained.

3. When satisfied, click **“Save”**. The photo saved in the size or aspect ratio.
4. Click **“Done”**

Resizing Photos

Clicking **Resize Photo** lets you change the size of your photo image.

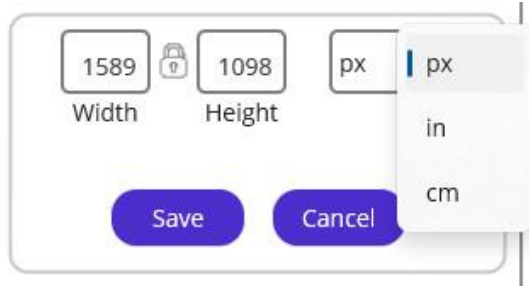

In addition to being able to change the width and height, you can select **px** (pixels), **in** (inches), or **cm** (centimeters) from the dropdown.

1. When satisfied with your changes, click **Save**.
2. Click **Resize Photo** again to collapse the choices.

Tools Panel

The **Tools** panel provides quick access to enhancement features, as well as other tools like filters and borders. Select **More** > or < **Less** for fewer feature options.

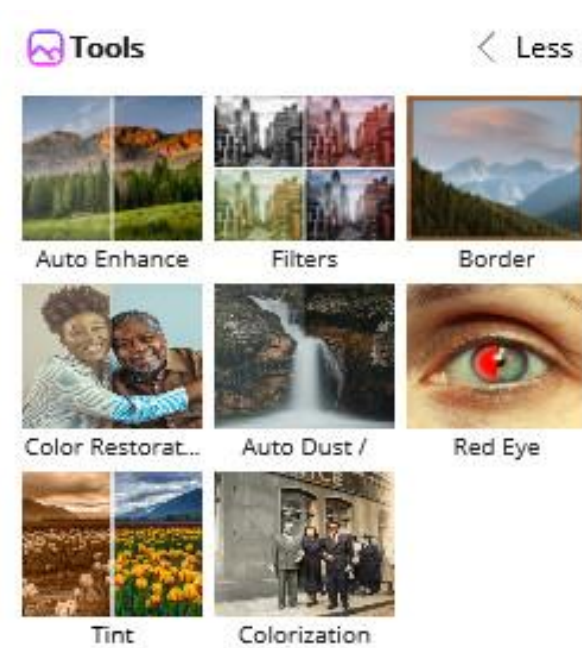

Auto Enhance – Automatically improve the quality of you old photos with a single click.

1. Select a photo image to apply the enhancement.
2. When satisfied, click **Done**.

Filters – Choose from a selection of filters providing various effects to transform the look and feel of your photos.

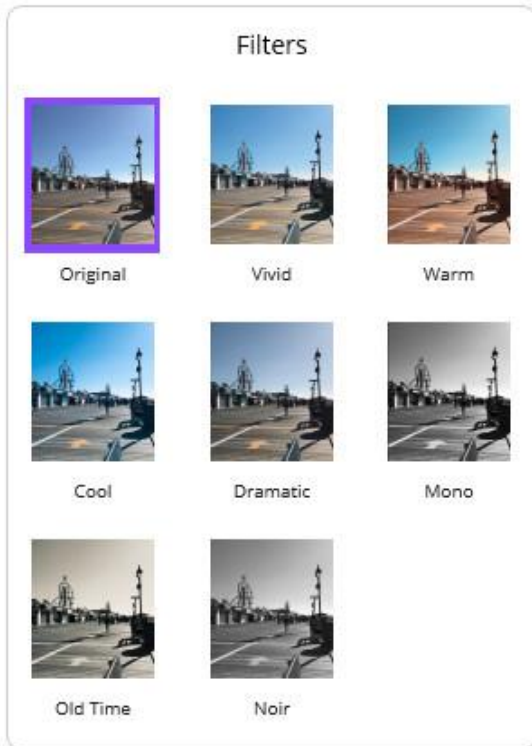

1. Select a photo image from the viewer and apply a filter.
2. When you achieve the desired outcome, click **Done**.

Border – Opens a panel for selecting the Thickness, Corner Radius, and Color of the Border you apply.

1. Use the sliders to select the border Thickness and Radius.

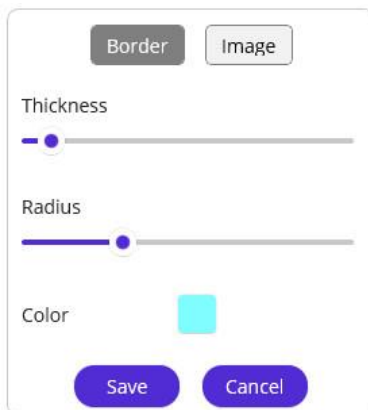

2. Click the colored square to select the Border Color.
A color gradient box opens.

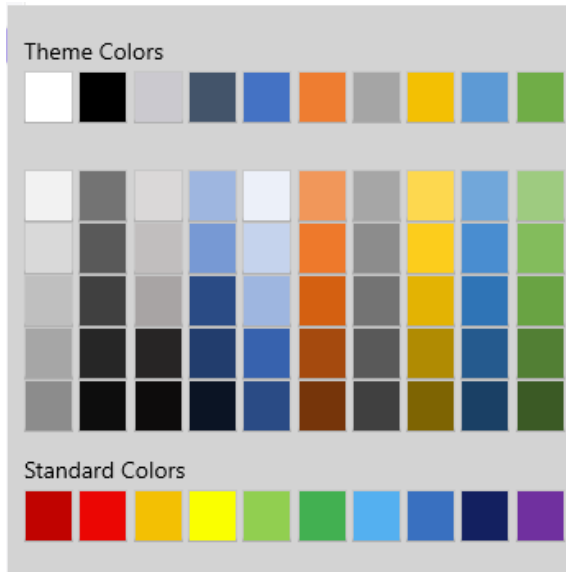

3. Select the desired border color, then click "Save".

Color Restoration – Can be used to revitalizing the colors in faded old photos, making them more vivid.

Auto Dust / Noise – Is designed to remove digital noise and imperfections resulting from dust on old photos.

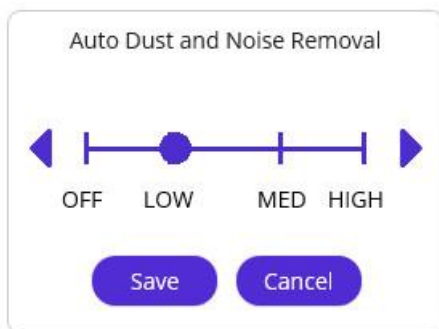

Click the left and right arrows to adjust the amount of correction.

Red Eye Removal – Helps remove the effect of light reflecting back from the retina.

Click the filter when needed to remove the effect.

Tint – For special tinting effects.



1. Drag the circle around in the color gradient box until you get the tint you're looking for.
2. Drag the circle in the vertical bar up (lighter) or down (darker) to fine-tune the tint.
3. Use the dropper to select a color from the photo on the canvas.
4. When desired tint is achieved, click **"Save"**.

Colorization – Uses AI to analyze tones and infuse color into grayscale photos, revitalizing the details with a palette of colors that will feel as real as the moment they were captured.

PictureStudio

Colorization AI analyzes tones and infuses color into your grayscale images, revitalizing the details with a palette of colors that will feel as real as the moment captured.

Colorization AI is in beta, which means it's still evolving and may have a few quirks as we work towards perfecting this feature.

Do not show this message again

OK

1. Click an image to select it.



2. Click the **Colorization Tool**.

PictureStudio

Colorization AI will add a touch of color to your original photo.

If you check duplicate the original, we will automatically create and save a duplicate copy in the same folder to preserve an original copy.

Duplicate the original

3. Checking **Duplicate the Original**, automatically saves a duplicate copy of the original photo.
4. Click **“Colorize”**, and proceed through the options presented.

PictureStudio

Depending on the size of your image file and processing speed, this process may take up to several minutes.

A red processing notification icon will appear in the top bar. It will disappear when processing is complete.

The colorized picture will be in the same folder as the original.

Do not show this message again

5. Click “Continue”, to begin the colorization process.

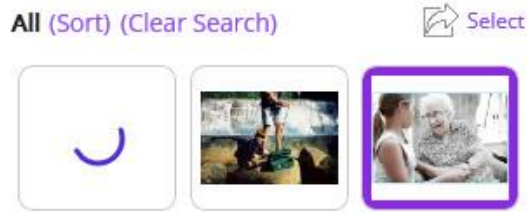

When complete, the colorized photo is added to the original folder.

If “duplicate the original” was selected, the original photo will appear in the same folder alongside the colorized photo.

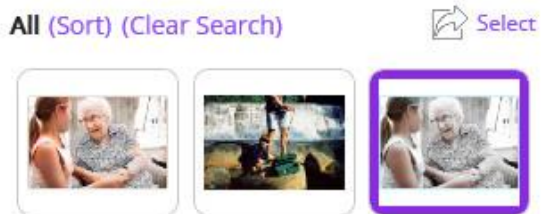

Advance Settings

The Advance Setting panel includes individual slider controls for Exposure, White Balance, Saturation, Brightness, Contrast, Sharpen, Blur, Hue, and Gamma with individual controls for the color channels. The vertical line on each slider indicates the default value, but you can change the settings by dragging the circle along its line.

1. To see more Setting, click **More >**.



2. **Exposure:** Increasing exposure can help bring out aspects in a photo that were originally dark, or hard to see, to be more visible and stand out. The adjustment affects the brightness of the photo without affecting tone. (Helpful tip, when increasing exposure dust may become pronounced in the photo and using the Dust Removal feature after adjusting Exposer will help with image quality!)
3. **White Balance:** This tool adjusts the color in the photo but does so over a limited range. The tool is best for making slight color adjustments to the entire photo
4. **Saturation:** Adjusting the slider to the right increases how much of the color in the photo you want to increase. Helpful to give your photos a more vibrant feel to the colors. Moving the slider to the left reduces your colors and makes the photo appear gray.
5. **Brightness:** Moving the slider to the right or left will adjust the overall lightness or darkness of a photo. Think about how much light is in the photo, when the slider is moved to the right the photo becomes lighter throughout the whole photo. Moving the slider to the left removes the light and makes the photo darker.
6. **Contrast:** When adjusting the slider to the right this increases the contrast which gives the photo more pronounced brightness. Moving the slider to the left decreases the contrast giving the photo more subtle brightness.
7. **Sharpen:** This setting adjustment allows you to enhance the details and edges of a photo. It helps create a more defined photo and can make your photos pop to look clearer and more refined.
8. **Blur:** This setting creates a blurring effect on a photo. This could be useful to add movement to a photo.
9. **Hue:** This feature is the same as white balance, adjusting the amount of color in a photo, but does so over the full range of colors. Adjusting it left or right, you will experience full color changes from the Red, Green, Blue (RGB) color spectrum.
10. **Gamma:** This is a non-linear contrast adjustment. This is helpful to bring out subtle differences in brightness in photos.
11. After adjusting the various controls to reach a desired outcome, click **“Done” to apply and save.**

Project Center

Transform your photos into stunning visual stores with PictureStudio's Slide Shows and Collages. Effortlessly combine multiple photos into captivating memories. Perfect for sharing memories, celebrating events, or showcasing your creativity.

Project Center

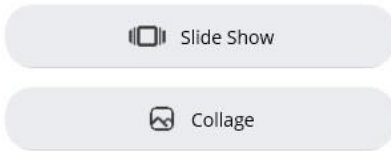

Slide Shows

Bring your photos to life with dynamic slide shows! Easily create engaging presentations with smooth transitions, customizable durations, and captivating effects.

1. Click **Slide Show**.

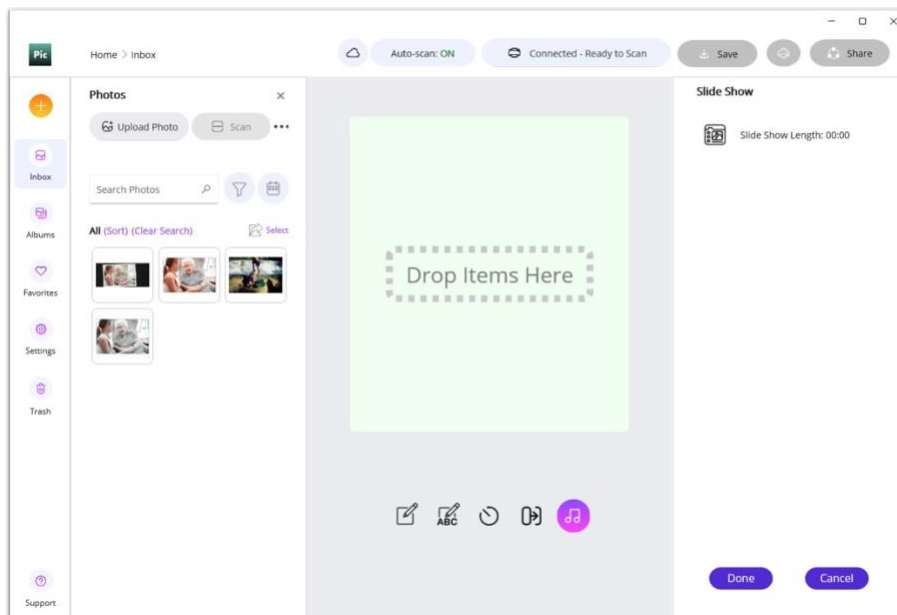

2. Please select photos for the Slide Show by dragging them from your inbox or albums onto the canvas. The chosen photos will appear in the order they were selected. You can rearrange the order by dragging and dropping images into your desired sequence.
3. To add text to your image, click the **"Add Text"** icon.



An option to change fonts, sizes, and colors is available.



7. After adding and editing text, click **“Done”**.
8. Click the Time Lapse icon to set the desired interval between images.



9. Select the time lapse between the photos. (Range: 3 to 60 seconds)



10. Select the Transition Type. (Transitions are only available on WINDOWS)



Transition Types

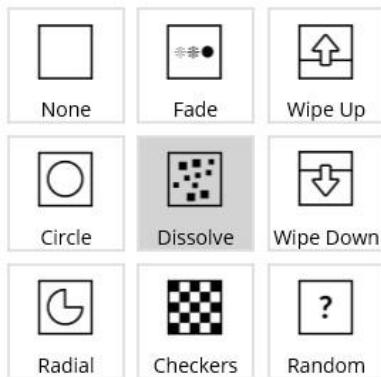

11. Add your favorite music track.



12. Click **Add** to find the track on your computer.



Add

10. After editing your Slide Show, click **“Done”** to review your selected choices.

Slide Show

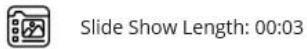

Save Slide Show: [Inbox](#)

12. Click **“Create”** to start creating your slide show.

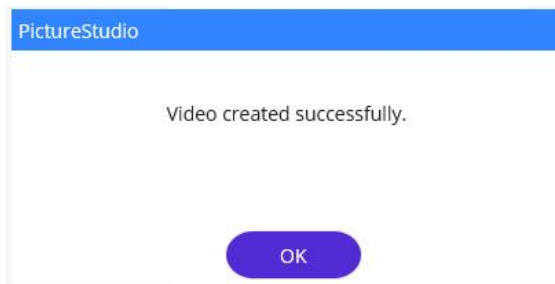

13. When complete, click **“OK”**. The completed Slide Show is saved to the Inbox.

Collages

Unleash your creativity by arranging your photos into custom collages. Choose from a variety of templates and effortlessly combine images to tell your story in a single frame. Perfect for uniquely showcasing your favorite moments!

1. Click **Collages**.

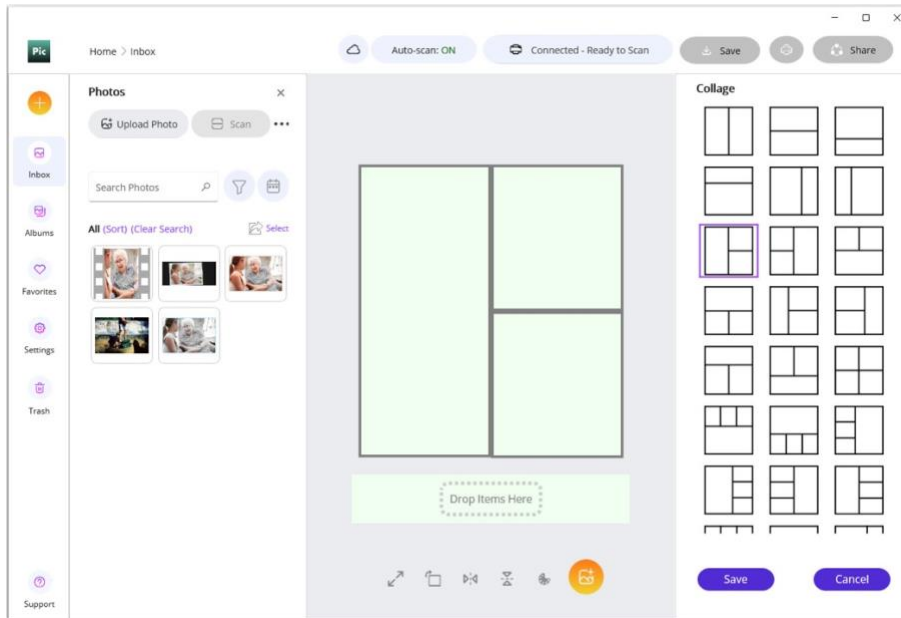

2. Select a desired format.
3. Drag and drop photos selected photos into the collage. Zoom and position each as desired.
4. Select size, then click **“Save”**.



6. Save your photos to the inbox or selected album.

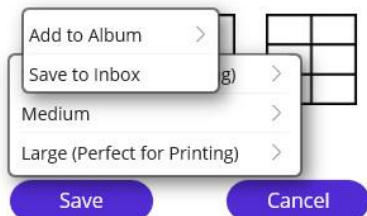

Settings



Click **Settings** to see the comprehensive list of the settings. This information will be important when you have some photos and want to select Scanner Settings, Application Settings, and your Sharing preferences for your photos with friends, social media, and other apps.

Scanner Settings: This area allows you to customize how your scanner interacts with the application, providing access to specific settings, and tools to clean and calibrate the scanner.

The screenshot displays the 'Settings' application interface. At the top, the title 'Settings' is shown. Below it, the 'Scanner Settings' section is visible. The settings are organized into several rows, each with a label on the left and a control on the right:

- File Format:** A dropdown menu currently set to 'PNG'.
- Resolution:** A dropdown menu currently set to '300DPI'.
- Scan Color:** A dropdown menu currently set to 'Color'.
- Auto Enhance:** A toggle switch currently in the 'Disabled' position.
- Auto-scan:** A toggle switch currently in the 'On' position, with a 'Settings' link next to it.
- Reduce Lines and Streaks:** A toggle switch currently in the 'Disabled' position.
- Calibrate:** A blue button labeled 'Calibrate'.
- Clean:** A blue button labeled 'Clean'.

Application Settings: This section provides control over the app’s functionality and user interface, including language preferences and application settings.

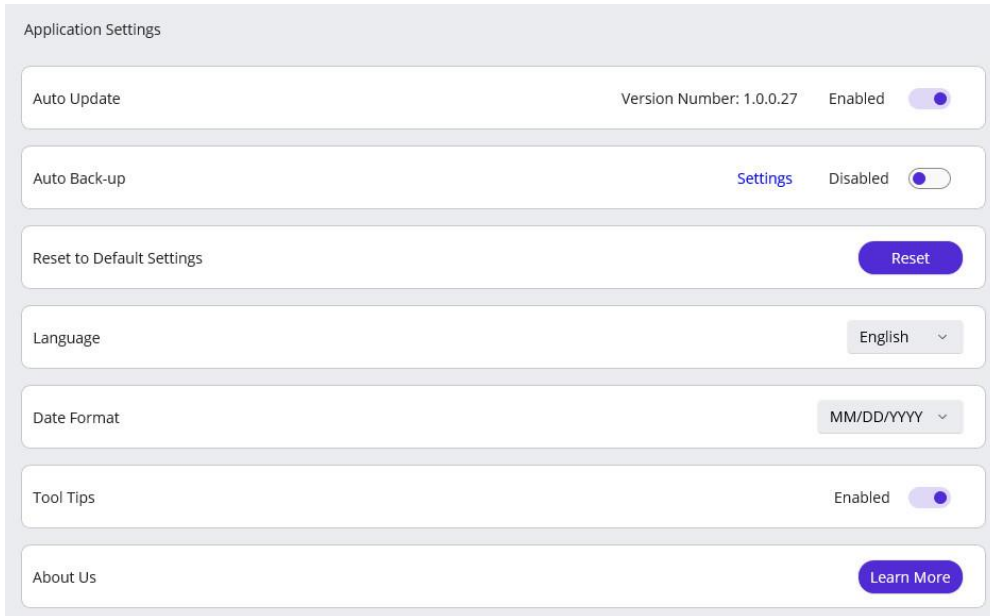

Sharing: These options enable you to configure, enable, and disable services that enable you to share photos with friends, family, and social media.



Auto Back-up

With our Auto Back-up feature, you can effortlessly save your entire photo library, including all albums, tags, and enhancements. If you ever change or need to replace your computer, restoring all of your precious memories is a breeze. Rest assured, your photos are securely saved, providing peace of mind and safekeeping for all your cherished memories.

To enable, configure OneDrive, iCloud, or Dropbox from the Sharing menu in Settings. One enabled, select “Configure” under Auto Back-up.

Trash



The **Trash** folder contains photos you don't want to keep.

Trash

The drop-down on the top right allows you to choose the viewing options from your deleted photos.

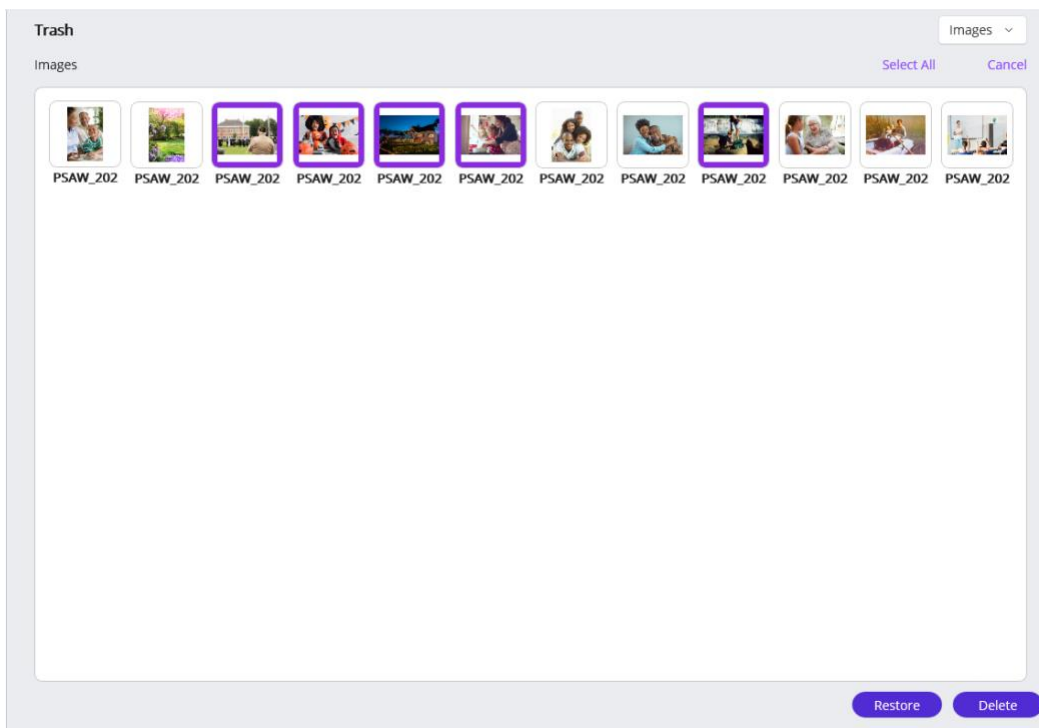

If you click on “**Select**” you have the option to restore any photos to their original location where they were deleted. You can also fully **Delete** the selected completely from PictureStudio.

Additional Help:

FAQ's: <https://picturestudio.com/faqs/>

Support: <https://picturestudio.com/support/>

Website: <https://picturestudio.com/>